

ULTIMATE WEB BLASTER

Thank you for purchasing the SPIDER-MAN ULTIMATE WEB BLASTER. Please read and retain these instructions.

WARNING:
Pressurized container. Read all instructions before use.

CAUTION: Do not aim at eyes or face.
TO AVOID INJURY: Use only darts designed for this product. Do not modify darts or dart blaster. To avoid injury use only clean tap water.

Make sure to use only SPIDER-MAN 3 Web Fluid Refill canisters with this blaster!

Includes:

- One 5 oz. (142 grams) can of double stream Web Fluid
- Ultimate blaster housing
- Gauntlet
- Water tank
- 5 missiles
- 1 suction dart
- 3 stretchy webs
- Missile Blaster Module
- Suction Dart Blaster Module
- Stretchy Web Blaster Module

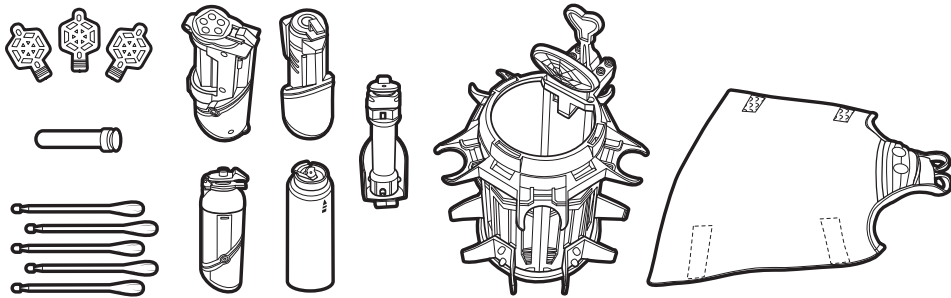

Loading Blaster Modules:

Load Blaster Modules onto Blaster Housing. Lower rear end (with tab) into housing, then snap ring on Modules into Holding Clips. Modules fit anywhere on Housing.

NOTE: There are special instructions for attaching the Web Blaster and Water Shooter. Please see instructions for those modules below.

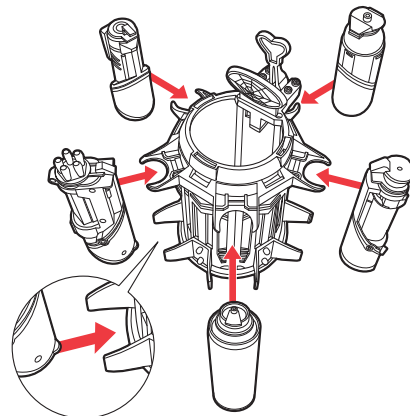

Choosing a Blaster:

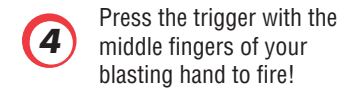
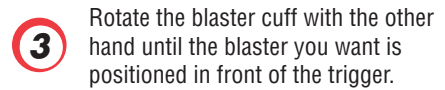
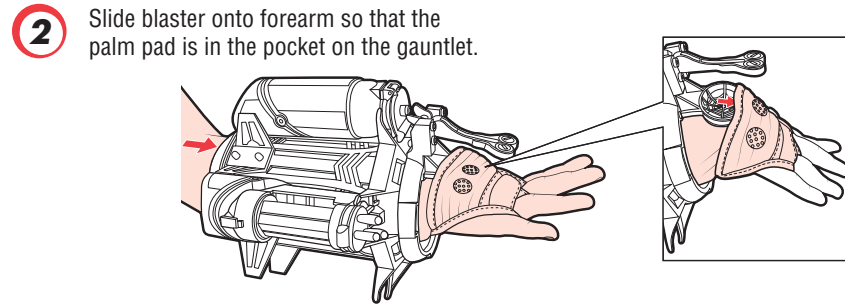
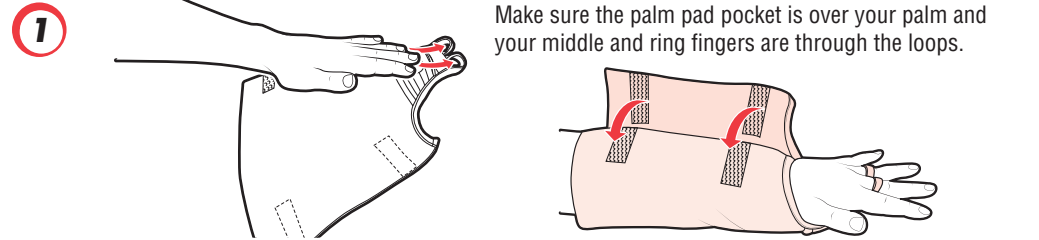

Web Blaster Assembly & Use:

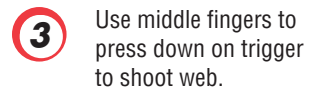
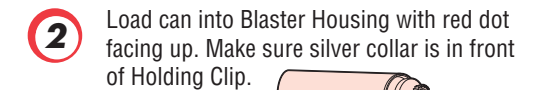
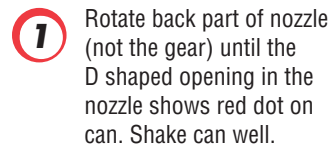

For Best Performance:
-Note: Can must be installed in blaster with the red dot facing up.
 -Keep Web Fluid at room Temperature
 -Shake Can very well before each use
 -Make sure the red mark on the top ring of the can is facing up
 -Aim can slightly up from horizontal for best performance
 If Web Fluid is not shooting very far, shake can again.
 If Web Fluid is not coming out, make sure the nozzle is clean.
 To clean the nozzle, pull the gear assembly off of the can.
 Clear Web Fluid away from plastic nozzle, and inside of gear. Snap gear assembly back onto can.

Note: Clear nozzle of any excess string for best performance. For best results aim slightly upwards.

Water Shooter Assembly & Use:

- 1** Unscrew cap and fill tank with clean water. Replace cap.

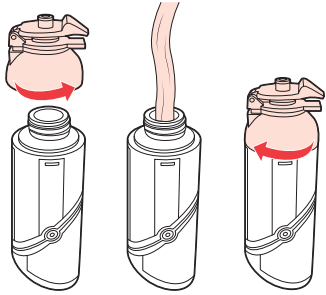

- 2** Snap ring on Water Tank into Holding Clip on Blaster Housing.

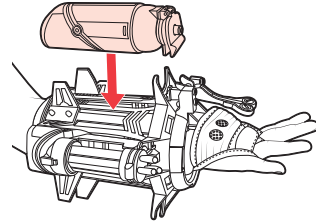

- 3** Pump trigger 15 times or until water shoots.

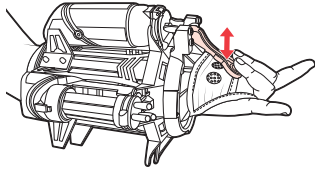

- 4** Press trigger with middle fingers to shoot water.

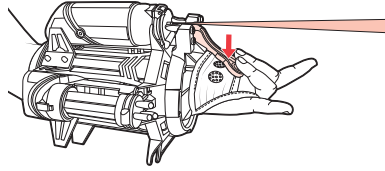

Missile Blaster Assembly & Use:

- 1** Insert 5 missiles into Missile Blaster.

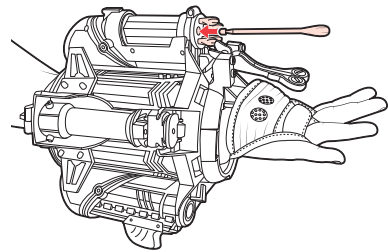

- 2** Use middle fingers to press down on trigger to shoot missiles. Missile Blaster will advance automatically. Press trigger repeatedly to blast all 5 missiles.

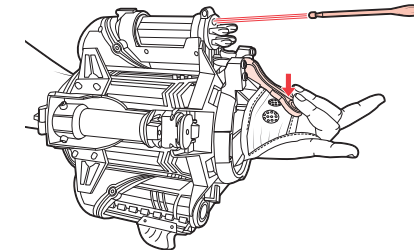

Stretchy Web Blaster Assembly & Use:

- 1** Attach 1 web to each firing location on the Blaster Module by hooking one loop over the hook on the front of the Module and the other over the tab at the rear of the Module.

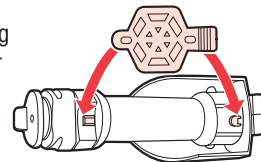

- 2** Use middle fingers to press down on trigger to shoot webs. Web Blaster will advance automatically. Press trigger repeatedly to blast all 3 webs.

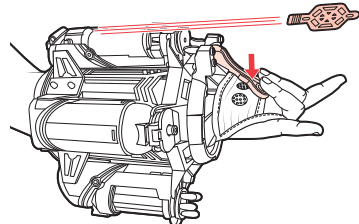

Suction Dart Blaster Assembly & Use:

- 1** Load 1 suction dart into the Blaster.

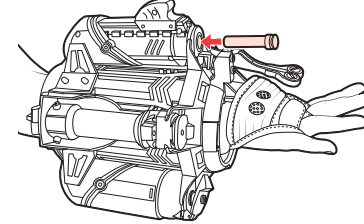

- 2** Pull back slide on Blaster to cock.

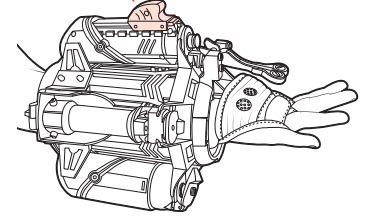

- 3** Use middle fingers to press down on trigger to shoot the dart.

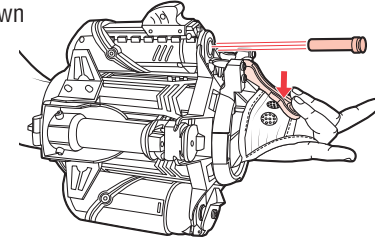

WARNING:

Contents Under Pressure.

Adult Supervision Required.
Non-Toxic.
Non-Flammable.
Not Recommended for Indoor Use.

Do Not Puncture Or Incinerate.

Do Not Expose to Heat or Store at Temperatures above 120° Degrees F / 48 Degrees C.

- Do Not Spray on Open Flame or Any Hot Stoves or Light Bulbs.
- Do Not Leave in Direct Sunlight or Store in a Hot Vehicle.
- Heat Can Cause Can to Burst Violently.
- Do Not Spray in Eyes or Face.
- Do Not Ingest String.

Shake well before using.

Can should be used in a horizontal position.

CAUTION:

Do not spray on walls, floors, clothing, furniture or vinyl as string may stain certain types of surfaces and fabrics. USE ONLY AS DIRECTED.

Ingredients: Water HFC 134a (propellant), Acrylic Resin, Hydrocarbon solvents, Light oil, Pigment.

P/N: 6678270000

COLUMBIA PICTURES
© 2006 COLUMBIA PICTURES INDUSTRIES, INC. ALL RIGHTS RESERVED.

www.hasbro.com/spiderman

SPIDER MAN
MERCHANDISING



Not suitable for children under 3 years because of small parts — choking hazard.



Spider-Man and all related characters and the distinctive likeness thereof: TM & © 2007 Marvel Characters, Inc. Spider-Man 3, the Movie: TM & © 2007 Columbia Pictures Industries, Inc. All rights reserved. ®* and/or TM* & © 2007 Hasbro. All Rights Reserved. TM & © denote U.S. Trademarks.