



© 1995, 1996 and 1998 NINTENDO,
CREATURES, GAME FREAK.
TM & ® are trademarks of Nintendo.
© 1999 Nintendo.

TIGER
ELECTRONICS, LTD.

©, TM, & © 1999 Tiger Electronics, Ltd.
All Rights Reserved
980 Woodlands Parkway
Vernon Hills, Illinois 60061, U.S.A.
www.tiger toys.com

891510001/WT1-01

TIGER
ELECTRONICS LTD.
Ages 7 and Up

POKÉMON
Gotta catch 'em all!

CYCLONE 2



INSTRUCTIONS

Model 89-151

CONTROL GUIDE

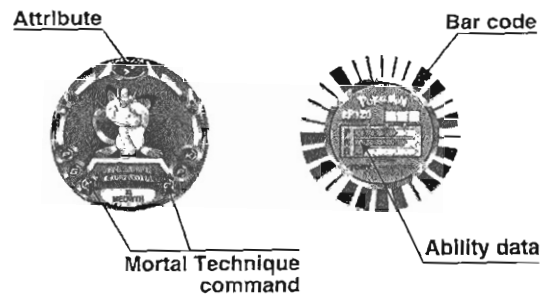
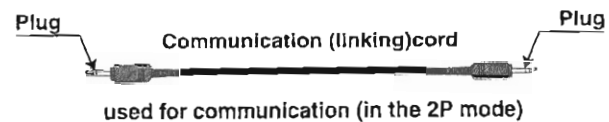
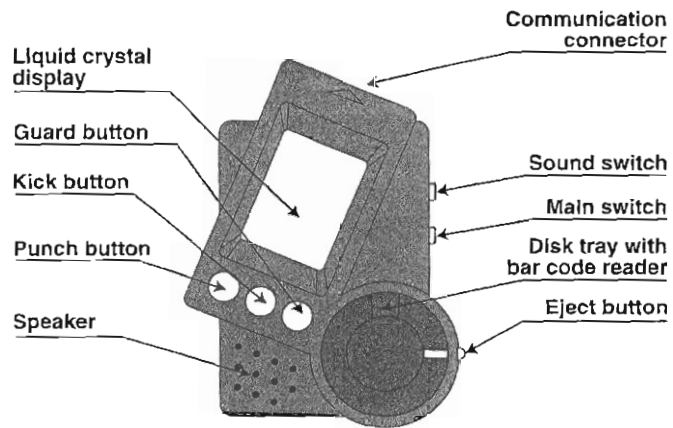

Items on the LCD:

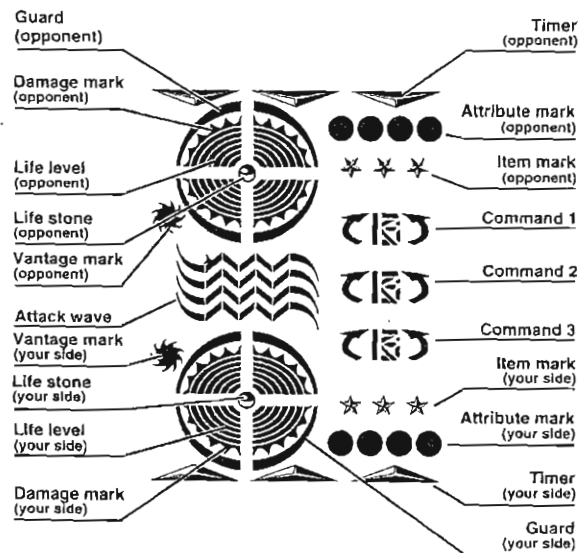

SET UP

● Installing batteries

Make sure the switch is in the OFF position before installing the batteries. Loosen the screw from the battery lid, remove the lid, and install three AAA batteries according to the + and - marks.

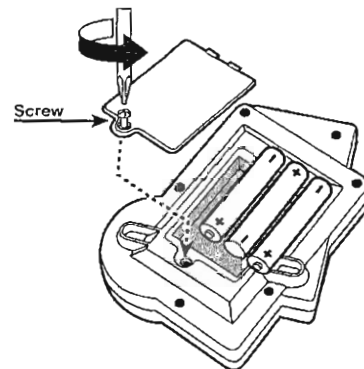

After installing the batteries, make sure that you put the screw back and tighten it.

Note: Pokémon Challenge has an auto power off function. The power will automatically shut off after three minutes if no buttons are pressed.

● **Connecting the communication cord**

You need to connect the communication cord only when selecting the 2 Player mode.

Insert the plugs securely into both Pokémon Cyclone 2 units.

● **Setting a disk**

Pokémon disks are placed on the circular tray located on the front of the unit. Disks should be placed with the character picture facing up so the bar-code information faces down over of the reader. To remove a disk, slide the ejector button (located on the side) up and take the disk off of the tray.

SELECTING A MODE:

There are 3 different game modes in the Pokémon Cyclone 2 game: 1 Player mode, 2 Player mode, and Research mode.

1 Player:

In the 1 Player mode, you are playing on your own, fighting a battle with a computer controlled Pokémon. You need to read one battle disk for the computer and another disk for yourself.

2 Player:

In the 2 Player mode, you can fight a head-to-head battle against a friend! Connect two Pokémon Cyclone 2 units using the communication (linking) cord.

Note: In the 2 Player mode, you need two Pokémon Cyclone 2 units (purchased separately) to play.

Research mode:

In the Research mode, there is no attack from your opponent so you can practice your attacks and experiment with the abilities of the different Pokémon disks. This is useful for finding hidden commands. Experiment by using different button combinations to launch attacks.

PLAYING A 1 PLAYER GAME

Shift the main switch to the 1 Player position. The graphics at the top of the screen will light up to indicate the computer's position. The computer will play at the top of the screen and you will play from the bottom. This means the computer will launch attacks down at your circle while you will be launching attacks up at his. The object is to destroy all the rings of your opponents circle before he destroys yours.

Before each battle you will need to select 1 Pokémon disk for the computer and then another for yourself. You will then need to "read" each disk into the unit so the Cyclone 2 knows the abilities of each Pokémon. Information is read from the bar code located on the back of each disk.

Reading in a Pokémon disk for the computer:

- 1) Select a Pokémon disk for the computer (your opponent). The top circle should be flashing to indicate a disk needs to be read in for the computer.
- 2) Place the disk on the tray with the bar code information facing down. Rotate the disk clockwise for four to five revolutions. This can be done by using your thumb or forefinger to spin the disk on the tray (like a record spins on a turntable).

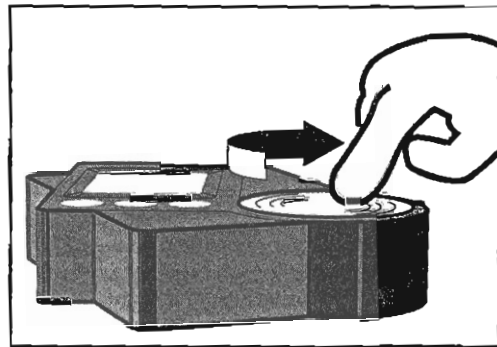

- 3) Continue to rotate the disk until the 3 arrows at the top of the screen disappear and the letters P, K, and G appear on the right side. This indicates the disk has been successfully read into the unit.
- 4) The computer's circle now displays the Pokémon's ability range. You will notice the 4 quadrants of the circle each have a different number of rings. The number of rings represents the relative strength/skill of the Pokémon's Life Level (L), Punch Power (P), Guarding power (G), and Kicking power (K). The number of items and attribute marks is also shown at the same time.

- 5) Press the G button to exit the computer opponent setup.
- 6) The bottom circle will now be flashing to indicate your Pokémon disk must now be read in.
- 7) Place your Pokémon disk on the tray and follow the above steps to read in your disk. When the disk is successfully read into the unit, press the G button.
- 8) Now it is time to adjust the computers skill level. Once you press the G button you will see one quadrant of the computer's circle is lit up. This represents skill level 1. To increase the skill level press the P button. Each time you press the P button another quadrant appears. The computer has 8 skill levels (skill level 8 is selected when both circles are full). To decrease the skill level press the K button. NOTE: you cannot decrease the skill level below 1 which is the computer's starting level. The computer's level will automatically increase as you win battles.
- 9) Press the G button again to begin the countdown to the game.

Countdown:

- 1) Both timers start counting down for a battle!
- 2) You'll hear a battle sound and the battle starts!

STARTING THE GAME IN 2 PLAYER MODE

Make sure the main switch is in the OFF position on both units. Connect two units by inserting the communication (linking) cord plug into the connector socket on each Cyclone 2 unit. Shift the main switch to the 2P position of the two units, one after another. The opening screen of the 2P mode will start.

Note: When shifting the main switch to the 2P position, do not shift the switches of the two units at the same time, or the computer may fail. Always shift the switches one after another.

READING IN A DISK

- 1) Both players should select a Pokémon disk for use.
- 2) Place your disk on the disk tray and read it in as you would in a 1 player game.
- 3) Once your disk is successfully read in, you can view your Pokémon's ability range. Press the G button and now your screen shows the ability range of your opponent's Pokémon! Your Pokémon's ability range will also appear on your opponent's Cyclone 2 unit.
- 4) After checking the ability range, press the G button and the countdown to battle begins!

Countdown:

- 1) Both timers start counting down for a battle!
- 2) You'll hear a battle sound, and the battle starts!

STARTING THE GAME IN RESEARCH MODE

While holding down one of the P, K or G buttons, shift the main switch to the 1P position, The Research Mode opening screen is displayed.

Note: If you hold down the P, K and G buttons all together, and put the power on, you will go to the All Illumination Mode. This mode is used to check the LCD, and it is not related to the game.

Setting a disk for your computer opponent:

Game setup is the same as the 1 player game. You will need to first select and read in a disk for the computer, then choose one for yourself.

Note: In the Research Mode, your screen keeps showing your ability range after countdown.

Countdown:

- 1) Both timers start counting down for battle!
- 2) You'll hear a battle sound and the battle begins!

What you can do in the Research mode:

In the Research mode, there is no attack from the computer opponent. Enter various commands continuously, and find out the following:

- 1) How fast can you knock down the Pokémon that you have selected?
- 2) What is the effect of your Mortal Technique?
- 3) Find commands for hidden attacks and items.

If you want to change your battle disk, press the K and G buttons at the same time for a few seconds. Then read in a new disk for yourself.

If you want to change the battle disk of your computer opponent, press the P and K buttons at the same time for a few seconds.

If you want to fill up the life of your computer opponent, press the P and G buttons at the same time for a few seconds.

HOW TO FIGHT A BATTLE

Each player takes a turn to launch either an attack or defense. The three arrows at the top and bottom of the screen indicate who's turn it is. You are given a 3 count to launch your move. With each count, one of the arrows disappears. If you have not launched a move by the time the arrows are gone, then you lose your turn.

To give punches, kicks, or to guard yourself in battle, hold down the P, K or G button, and rotate the battle disk right or left. The button represents a type of attack, and the rotation of the battle disk determines the right and left direction.

Left punch - Hold down the P button, and rotate the battle disk clockwise.

Left kick - Hold down the K button, and rotate the battle disk clockwise.

Right kick - Hold down the K button, and rotate the battle disk counterclockwise.

Right punch - Hold down the P button, and rotate the battle disk counterclockwise.

Guarding will place a shield around your circle and absorb enemy attacks.

Left guard - Hold down the G button, and rotate the battle disk clockwise.

Right guard - Hold down the G button, and rotate the battle disk counterclockwise.

Mortal Technique:

Each Pokémon has a Mortal Technique that is very powerful and can attack many positions with just one move. To use a Mortal Technique, use a combination of right/left punch, kick, and guard commands in three turns.

Note: the 3 commands for the Mortal Technique move appear on the front of each Pokémon disk!

Example:

A. Press the "G" button and rotate disk clockwise until your turn is complete.

B. For your next attack, press the "K" button and rotate the disk clockwise.

C. Next press the "P" button and rotate the disk clockwise to complete your 3rd turn. If you have found the correct sequence of moves for the Mortal Technique, this last turn will be super powerful!

Note: the 3 commands for the Mortal Technique move appear on the front of each Pokémon disk!

Double Grand Attack command:

The Double Grand Attack will hit the two bottom positions with two attacks! To do this you need to find the correct sequence of moves just as with the Mortal Technique

Items:

It is possible that your Pokémon has an item that can be used during battle. If the battle disk has a star mark on its back, it must have a hidden item!

To use an item, like the mortal technique, use a combination of right/left punch, kick, and guard commands in three turns. Use the Research Mode to search for the correct sequence! If an item has been enabled, the star will flash. When the item is used up, the star will disappear.

Screen display during a battle:

Timer arrows - You must enter one command before the three timer marks disappear. The timer arrows will appear on the side of the player who's turn it is.

Attack wave - When you use a kick or punch, the wave goes towards your opponent. The wave becomes bigger when you use a mortal technique or other powerful technique.

Damage mark - The damaged position flashes after an attack has been carried out and 1 or more rings will disappear from the circle.

Life points - Life points are indicated by the six rings in each of the 4 quadrants of the circle. Each time you are hit, these disappear. When all your rings are gone, you have been defeated.

Command display - The screen shows the last three commands that you entered. Each new command is added at the bottom.

Guard marks - These are the shields that appear around your circle when you choose to Guard.

Item mark - The number of stars indicates the number of items that you have. The star flashes when it is enabled, and it disappears when it loses the power.

Attribute mark - This mark indicates any special attribute of the Pokémon disk (if any). The mark that is not filled black is the attribute of the Pokémon.

Vantage mark - This mark is illuminated on the side having the advantage or stronger Pokémon as determined by the combination of attributes between the two.

EXAMPLE OF BATTLE

The side that begins the attack is automatically determined based on the basic ability. The side that is lower in the basic ability begins the attack.

- 1) Your turn (assuming you have the weaker Pokémon)
After the opening countdown is finished, the three turn arrows are displayed on your side. The marks disappear one after another. Enter a command before all the marks disappear.

- 2) Giving a right punch
Holding down the P button, rotate the battle disk clockwise to send a right punch.
- 3) Damage to the opponent
The attack wave goes towards the opponent, and it will hit the opponent on its right.

Changing the turn:

- 4) Now it's your opponent's turn!
- 5) Your opponent sends a Left kick.
- 6) You take damage

Now it's your turn again! Play continues.

HINTS

1. Attack four positions effectively! Make sure to attack the side that still has life points!

2. Attack quickly! Before the turn arrows disappear, enter a command quickly. If you are too slow, all turn arrows will disappear and you will lose your turn.
3. Rotate the disk quickly to increase the attacking power! Check out the attack wave. It is different when rotating the disk faster!
4. Use your Pokémon abilities to your advantage. Each Pokémon has different strengths and weaknesses.
5. Find and use the Pokémon Mortal Technique: Every battle disk has a Mortal Technique that can hit many positions with one attack. It is a very powerful move when used correctly.
6. Find hidden items. Nobody really knows how many items there are, or what item each battle disk has. Find powerful items during a battle, or in the Research Mode!

GAME OVER

When the life points are down to zero for all four positions, the player is dead, and it is "game over".

When you win the opponent explodes. The winner is displayed. Then standby for another battle!

After a “game over”, press the P button for a rematch using the same Pokémon that you have already read from the battle disk. (When you are in the 1 Player mode, the computer level is displayed before countdown.)

Press the G button to clear the disk data that you used for the previous battle, and the screen changes so you can now read in 2 new Pokémon disks.

IF YOU CONTINUE TO WIN

If you continue to win, the computer level increases! So in either the 1 Player mode or the 2 Player mode, if you continue to win battles, the skill value of your opponent increases! So play is progressive—as you win and get stronger, the computer’s ability gets tougher, too!

Faster change of turns:

As you continue to win and the skill value and power of opponent increases, the change of turn becomes faster and faster!

What is the skill value?

The Pokémon Cyclone 2 remembers the number of wins and losses of the battles in the 1 Player or the 2 Player mode. The skill value is equal to (number of wins) - (number of losses).

Unfortunately, the Pokémon Cyclone 2 has no backup battery. So, when you remove the batteries, for example when replacing old batteries, the skill value goes back to zero. You have to start fighting battles, starting from the zero skill level again.

Note: As long as the batteries are installed and functioning well, the skill value does not go back to zero—even when you turn the main power switch off.

Note: However, if you do not use the unit and leave it for an extended period of time, even with the batteries installed and in working order, the skill value may go back to zero.

TROUBLESHOOTING

If you cannot get the power to turn on:

Are the batteries too old? If they are, replace them with new ones. Did you install the batteries correctly? Open the battery lid and check it to be sure.

If the computer does not read the battle disk:

Are the batteries too old? If they are, replace them with new ones. Rotate the disk quickly for five to six revolutions, smoothly without stopping. Is

the battle disk dirty? Clean it, and try it again. The sensor may not read the bar code when receiving direct sunlight or other strong lights.

If the communication (linking) plug appears not to work:

Are the batteries too old? If they are, replace them with new ones. Did you insert the plug securely? Check it out, and try it again. Did you go through the procedure correctly to start the communication (the 2 Player mode).

Check the instruction manual again, before you retry.

If the screen is not clear:

Are the batteries too old? If they are, replace them with new ones.

If there's no sound:

Did you turn on the sound switch? Check it to be sure.

If it is difficult to rotate the battle disk:

Do not force the disk to rotate, but gently touch the disk with a finger on the outer edge, and rotate the disk with your finger as if you are using a brush to rotate. Is the disk clean? Use a clean disk.

If no Mortal Technique is found:

Did you swap the disk after reading another disk? Try it again, watching the disk command that you have read in the unit. Cyclone 2 sometimes fails to read the battle disk. Read the battle disk again, and retry. You can use the Mortal Technique only when you use three commands in three turns. Make sure you use one command at a time.

CAUTION/DEFECT OR DAMAGE

To ensure proper function:

- Do not mix old and new batteries
- Do not mix alkaline, standard or rechargeable batteries
- Battery installation should be done by an adult
- Non-rechargeable batteries are not to be recharged
- Rechargeable batteries are to be removed from the toy before being charged (If removable)
- Rechargeable batteries are only to be charged under adult supervision (If removable)
- Only batteries of the same or equivalent type as recommended are to be used
- Batteries are to be inserted with the correct polarity

- Exhausted batteries are to be removed from the toy
- The supply terminals are not to be short circuited
- Replace with new batteries at the first sign of erratic operation

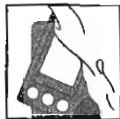

Clean only with a piece of soft dry cloth. Use a ball-point pen.

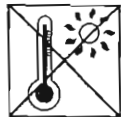

High temperature will destroy the unit. Do not leave unit in direct sunlight.

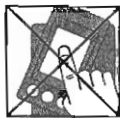

Do not press the liquid crystal display (LCD screen). Avoid heavy shock or the display may fail.

Caution when playing with Pokémon Cyclone 2

- 1) Do not insert the headphone plug or earphone plug into the communication connector of Pokémon Cyclone 2, or you may damage your ears.

- 2) Do not insert anything other than the accessory communication cord plug into the communication connector, and do not connect any electric device to it, or both Pokémon Cyclone 2 and the connected device may break down.
- 3) The communication battle may not work properly when using new and old electric cells together. Try to avoid using old cells.
- 4) The sensor may fail to read the bar code when in the direct sunlight or other intensive light. Use the unit inside the house, or in the shade.

DEFECT OR DAMAGE

If a part of your product is damaged or something has been left out, **DO NOT RETURN THE PRODUCT TO THE STORE**. The store doesn't have replacement parts. Instead, write to us at:

TIGER ELECTRONICS, LTD. REPAIR DEPT.
980 Woodlands Parkway,
Vernon Hills, Illinois 60061, U.S.A.

In your note, mention the name of your product, product's model number, and tell us briefly what the problem is. Also, include sales slip, date, place of purchase, price paid, and your return address, we will do our best to help.

90-DAY LIMITED WARRANTY

Tiger Electronics, Ltd. (Tiger), warrants to the original consumer purchaser of this product that the product will be free of defects in material or workmanship for 90 days from the date for original purchase. This warranty does not cover damages resulting from accident, negligence, improper service or use or other causes not arising out of defects in materials or workmanship.

During this 90-day warranty period, the product will either be repaired or replaced (at Tiger's option) without charge to the purchaser, when returned with proof of the date of purchase to either the dealer or to Tiger. Product returned to Tiger without proof of date of purchase or after the 90-day warranty period has expired, but prior to one year from the original date of purchase, will be repaired or replace (at Tiger's option) for a service fee of \$18.00. Payment must be by check or money order payable to Tiger Electronics, Ltd.

The foregoing states the purchaser's sole and exclusive remedy for any breach of warranty with respect to the product.

All products returned must be shipped prepaid and insured for loss or damage to:

Tiger Electronics, Ltd.
980 Woodlands Parkway
Vernon Hills, Illinois 60061 U.S.A.

The product should be carefully packed in the original box or other packing materials sufficient to avoid damage during shipment. Include a complete written description of the defect, a check if product is beyond the 90-day warranty period, and your printed name, address and telephone number.

THIS WARRANTY IS IN LIEU OF ALL OTHER WARRANTIES AND NO OTHER REPRESENTATIONS OR CLAIMS OF ANY NATURE SHALL BE BINDING ON OR OBLIGATE TIGER IN ANY WAY. ANY IMPLIED WARRANTIES APPLICABLE TO THIS PRODUCT, INCLUDING WARRANTIES OF MERCHANTABILITY AND FITNESS FOR A PARTICULAR PURPOSE, ARE LIMITED TO THE NINETY (90) DAY PERIOD DESCRIBED ABOVE. IN NO EVENT WILL TIGER BE LIABLE FOR ANY SPECIAL, INCIDENTAL OR CONSEQUENTIAL DAMAGES RESULTING FROM POSSESSION, USE, OR MALFUNCTION OF THIS TIGER PRODUCT.

Some states do not allow limitations as to how long an implied warranty lasts and/or exclusions or limitations of incidental or consequential damages, so the above limitations and/or exclusions of liability may not apply to you. This warranty gives you specific rights, and you may also have other rights which vary from state to state.

For more information about Tiger Electronics, our products and special promotions, please visit our web site at www.tigertoys.com.